

**FG Wilson P165-5**

**Open Genset**

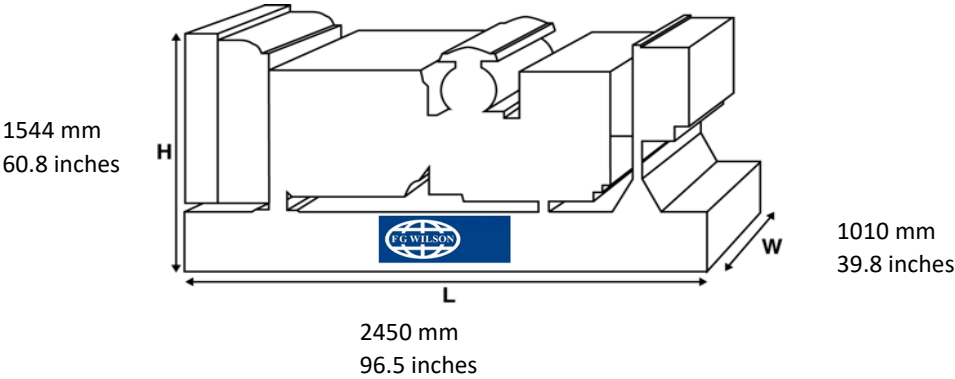

Weight with lube oil and coolant (no fuel) 1566 kg 3452 lb

**Enclosed Genset with CALG canopy**

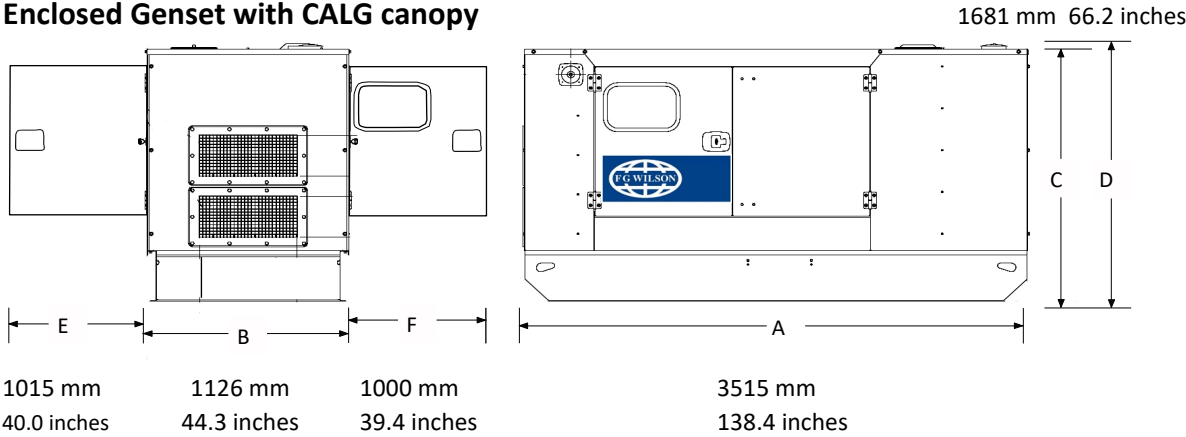

Weight with lube oil and coolant (no fuel) 1892 kg 4171 lb

**Enclosed Genset with CAE canopy**

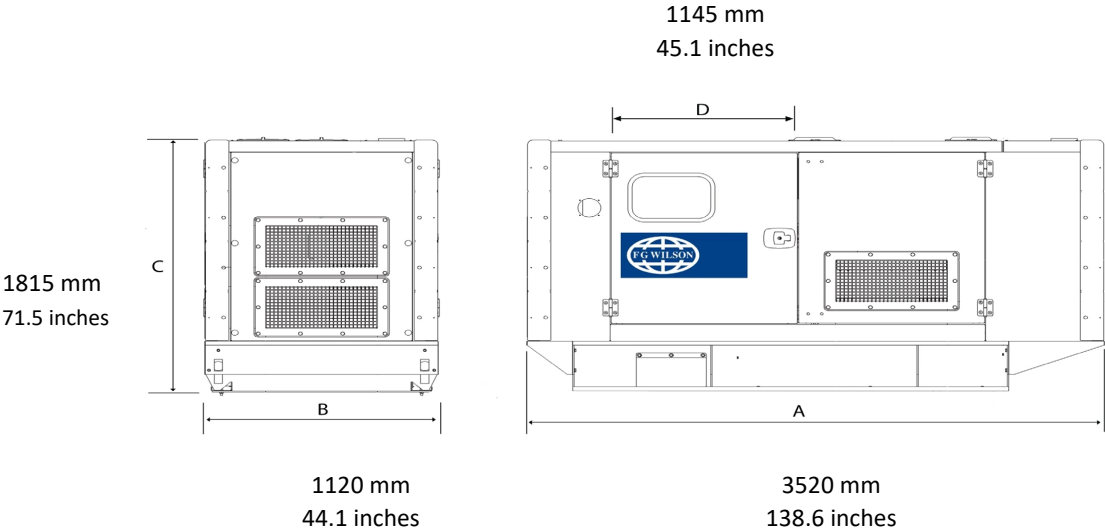

Weight with lube oil and coolant (no fuel) 2016 kg 4445 lb